

# Ananias Loves Paul

## Lesson Objectives

- The children will describe Ananias as a man who helped Saul even though he was afraid.
- The children will state that they can pray if they feel afraid and it will help them to be brave and friendly.
- The children will practice being giving and friendly with someone that they do not know.

## Lesson Text

Acts 9:1-19

## Scripture Memory Verse

At once he began to preach in the synagogues that Jesus is the Son of God.

*Acts 9:20*

## Lesson Plan

Greeting and Registration

Preclass Activity: Making Damascus

Welcome and Singing

Centers:

Bible Story: Ananias Obeys God

Life Application: Meeting New Friends

Craft: Puppet Saul

NOTE: Be sure to allow sufficient time for a snack.





# Ananias Loves Paul

## Making Damascus

The children will make the city of Damascus to be used in the Bible Story.

### Materials

*For each child:*

- crayons and markers
- cereal box, pasta box, or other small box
- butcher paper, newsprint paper, or brown paper bags to cover the box
- glue stick

*For the teacher:*

- butcher paper or newsprint
- tape

### Preparation

1. Wrap each box with the paper so that it is completely covered.
2. Before the children arrive place a large piece of butcher paper on a hard surface such as the floor. This will be the ground of the town.

### Instructions

1. Explain to the children that they are going to make a city from Jesus' time.
2. Give each child a covered box and markers or crayons. Have them decorate the box to look like a building.
3. When they have finished with their buildings have them color the butcher paper, drawing streets, trees, etc.
4. Give the buildings and the butcher paper to the Bible Story teacher.

### Conclusion

As the children are working, remind them of the Bible Story from the previous lesson. *In our last lesson we learned about a man named Saul. Do you remember what Saul was doing? (Going to Damascus to find Christians.) What happened to Saul as he was on his way to Damascus? (Jesus appeared to him and told him to stop hurting him and the Christians.)*

*Today you are going to hear more of the story of Saul and of how Saul became Paul.*

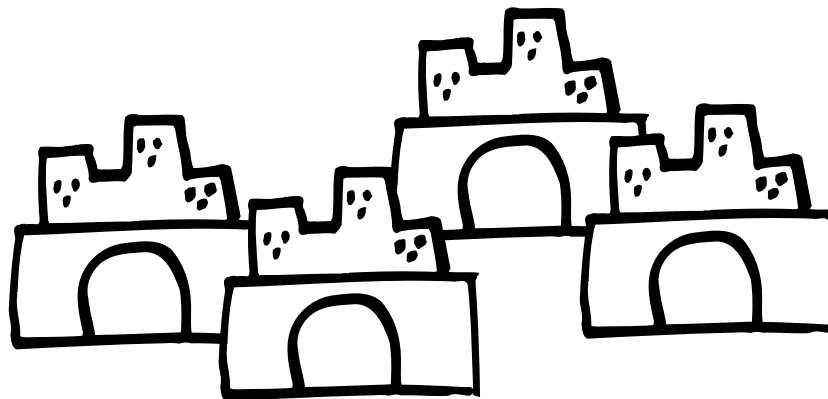

# Ananias Loves Paul

## Ananias Obeys God

The children will hear the story of Ananias healing Saul.

### Lesson Text

Acts 9:1-19

### Materials

For each child:

- Damascus props from the Preclass Activity

For the teacher:

- robe
- scarf
- Bible

### Preparation

1. Before the children arrive, put on the robe and scarf to make yourself look like Ananias.
2. Set up the city of Damascus from the Preclass Activity.

### From Saul to Paul

Open the Bible to Acts 9. *In our last lesson we learned about a man named Saul. Do you remember what he was doing in our last story? (Going to Damascus to find Christians.) What happened to him as he was on his way to Damascus? (Jesus appeared to him and told him to stop hurting him and the Christians.) When Jesus left, what happened to Saul? (He was blind and his friends led him to Damascus.)*

Show the children the city from the Preclass Activity. *This is Damascus. Encourage the children about the great job that they did building the city. It looks just like Damascus! You did a wonderful job! Oh there's the house that I visited once. It's on Straight Street. I will never forget that house! I was so afraid to go to that house. I must tell you that story!*

*I almost forgot to tell you my name. My name is Ananias. Can you say that? (Have the children repeat after you.) Let me tell you what happened to me. I am a disciple and I love God very much. I wanted other people to know about Jesus and how much he loves them.*

*One day I was in my house and guess what happened? The Lord came to me and told me to go see a man named Saul. He told me that Saul was praying and he was expecting me to come and help him to see again (Acts 9:11-12).*

*Well, I had heard about this man named Saul. He did not like Christians and he was coming to Damascus to hurt us. I had heard about how he had already hurt Christians in other towns. I was afraid to go to see him. Have you ever been afraid to talk to someone? I was really afraid, so I told God. I thought that maybe he did not know how mean Saul was. I thought that God was telling me to go to the wrong person. But do you know what? God is always right. He knows everything. He always knows what is best (Acts 9:13-14). God told me that he had great plans for Saul. That he was going to use Saul to teach many other people about Jesus (Acts 9:15). So what do you think I did? Do you think I obeyed? Yes I did, even though I was afraid. I did what God said. Show the children a path on the map that Ananias may have taken to get to Saul on Straight Street.*

*So I went to see Saul. When I got there he was still blind. God used me to heal him. I touched his eyes and immediately he could see again. Right away he got up and got baptized (Acts 9:18).*

*I'm not quite sure when Saul changed his name, but from that time on we all called him Paul.*

### Conclusion

*I was so happy that God used me to help Saul. Even though I was afraid at first, I'm glad I obeyed. Do you think God was happy when I went to help Saul? Yes! Do you think God wants to use each of you to help other people? Yes, he does. Who is afraid sometimes of meeting new people and talking to them or just even saying hello to them? What should we do when we are afraid? (pray) We should pray to God to help us to be brave. That will help us to be friendly and loving even if we are afraid. Of course make sure there is always an adult that you know with you when you are meeting someone that you have never seen before.*

# Ananias Loves Paul



### Meeting New Friends

The children will meet some new adults and will practice being friendly.

#### Scripture Memory Verse

At once he began to preach in the synagogues that Jesus is the Son of God.

*Acts 9:20*

#### Materials

None

#### Preparation

Ask two disciples that most of the children won't know to come to the class. Prepare the adults to be out of themselves and very friendly with the children. Make sure these disciples have been screened for the Children's Ministry. Explain to them that the class is learning the Bible Story in Acts 9.

#### Instructions

1. *In our Bible Story today we are learning about a man named Ananias who God sent to help Saul. Ananias was scared to go see Saul at first. But he went because he knew God wanted him to. Do you sometimes get scared to meet new people? We know that we should never talk to strangers if we don't have our families or another adult with us. But when there is an adult with us we should be very friendly, like Jesus.*
2. *Now, we are going to get a chance to be like Ananias and meet some new people.* Ask if any of them are afraid and then pray together. Some of them may want to pray about being friendly and loving.
3. Have the adults come in and sit with the group.
4. Have each child in the group introduce themselves to the adults.
5. Have the adults introduce themselves and tell a little about where they are from, if they are married, what they do for work, etc.
6. Have the children tell the adults a little about themselves, i.e., who they live with, if they have brothers or sisters, what they are learning in class, etc.

#### Scripture Memory Activity

Choose a child who knows the verse to tell it to the group. Have the visitors try to recite the verse. Have the children help them as necessary.

#### Conclusion

Have the adults and the children pray together to be friendly and obedient as Ananias was. Pray that they will please God as Ananias did. Have the adults pray briefly for someone that they are reaching out to.

#### Teacher Tips

- Be sure to prepare the adults to be friendly and out of themselves.



# Ananias Loves Paul

Life

A  
P  
P  
L  
I  
C  
A  
T  
I  
O  
N

At once he began to preach  
in the synagogues that Jesus is  
the son of God.

Acts 9:20



# Ananias Loves Paul

## Puppet Saul

The children will make a Saul puppet to remind them of the Bible Story.

### Materials

*For each child:*

- two white plastic or paper cups
- crayons or markers
- yarn, 8"
- scissors
- glue or tape
- decorative materials such as sequins and small pieces of fabric

*For the teacher:*

- scissors
- construction paper
- utility knife
- white glue

*Reproducible Pages:*

- Page A, 1 copy for every 10 children

### Preparation

1. Cut out the text boxes from the copies of Reproducible Page A.
2. Turn half of the cups upside down and cut two holes, 1/2" apart in each cup as eyes. See Figure A. NOTE: Each hole should be about 1/2" in diameter.
3. Cut the yarn into 2" pieces for hair.
4. Make a model of the craft following the instructions.

### Instructions

1. Give each child a cup with the holes cut out. Explain that the holes are eyes. Have the children color and decorate the cup to look like Saul as follows:
  - A. Glue the yarn on the top of the cup as hair.
  - B. Glue fabric on the cup as clothes.
  - C. Draw a face on the cup using markers and crayons.
2. Give each child a text box and have them glue it to the back of the cup.
3. Give each child a second cup and have them place the cup inside the cup with the holes in it.

4. Have them draw eyes through the holes onto the inside cup.
5. Have them turn the inside cup so that the eyes are not showing. This is Saul when he was blind. Then have them turn the inside cup so that the eyes show through the holes on the outside cup. This is Saul after he was healed.

### Conclusion

Have the children use their puppets to tell the story of Saul. Remind them that Saul was blind and then he was healed by Ananias so that he could see.

### Teacher Tips

- The children may need to use white glue to glue the decorative items on the cup.
- Be sure to briefly explain the craft to the parents as they pick up their children.

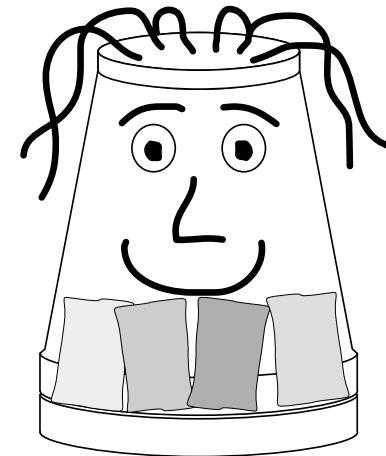

# Ananias Loves Paul

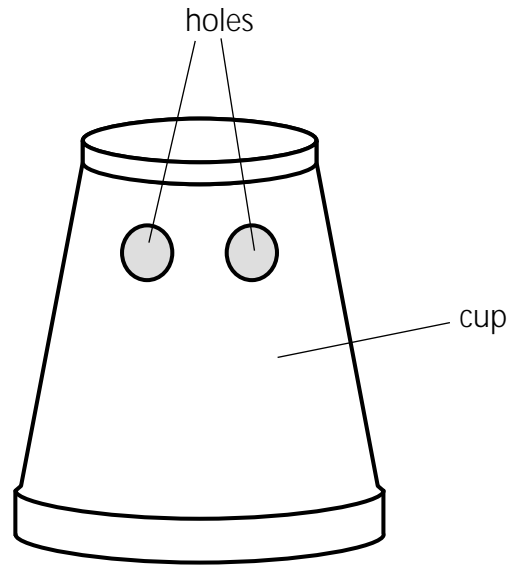
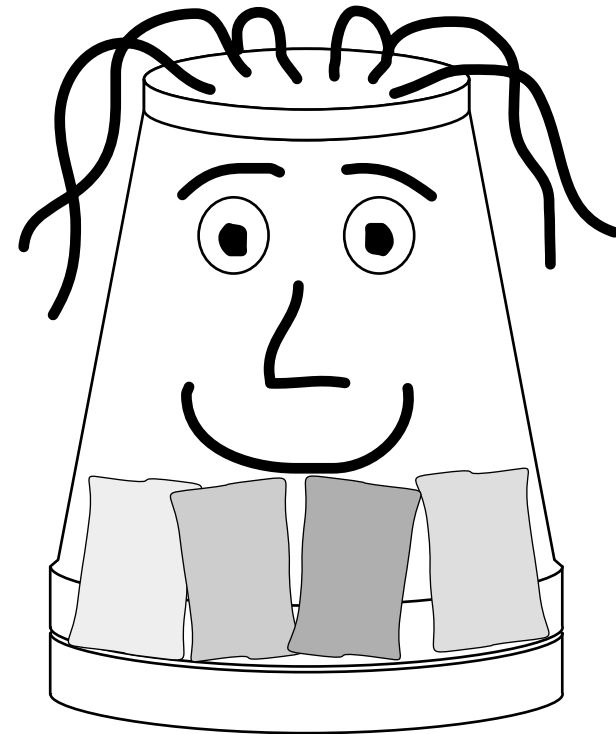

Figure A



Finished Craft







Pre class



# Ananias Loves Paul

## Missions

Lesson 2

### Lesson Objectives

- The children will describe Ananias as a man who helped Saul even though he was afraid.
- The children will state that they can pray if they feel afraid and it will help them to be brave and friendly.
- The children will practice being giving and friendly with someone that they do not know.

### Lesson Text

Acts 9:1-19

### Scripture Memory Verse

At once he began to preach in the synagogues that Jesus is the Son of God.

*Acts 9:20*

### My Scroll-1

The children will begin to make a scroll of pictures about Saul's conversion for the Craft.

#### Materials

*For each child:*

- 2 toilet paper rolls
- 2 pieces of construction paper, 4" x 6"
- markers or crayons
- 1 rubber band
- glue stick

*For the teacher:*

- scissors
- tape

#### Preparation

Cut two 4½" x 6" pieces of construction paper for each child.

### Lesson Plan

Greeting and Registration

Preclass Activity: My Scroll-1

Welcome and Singing

Centers:

Game: Going to Saul

Craft: My Scroll-2

Life Application: Meeting New Friends

NOTE: Be sure to allow sufficient time for a snack.

#### Instructions

1. Give each child the two pieces of construction paper to color.
2. Give each child two toilet paper rolls. Help the children to tape each piece of construction paper around each toilet paper roll.
3. Have the children color their rolls.
4. Have the children put their names on their rolls.
5. Help the children to put a rubber band around their two rolls to hold them together and give them to the Craft teacher.

#### Teacher Tips

- Be patient with the children, especially as you help them tape on the construction paper. Some cannot tape yet but will want to help with part of the taping. Let them hold the rolls or a piece of tape.

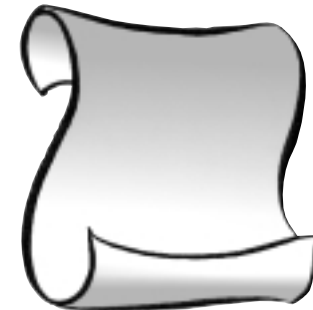



### Going to Saul

The children will pretend that they are taking the good news to Saul by playing a spoon relay game.

#### Materials

*For the teacher:*

- popcorn
- 2 soup spoons
- 4 bowls
- a robe and scarf (optional)

#### Preparation

1. Make some popcorn.
2. Familiarize yourself with the game.

#### Instructions

1. *Today we are going to play a game that will remind us of the Bible Story about Saul. You are going to pretend to be Ananias. He brought the good news to Saul that God was going to heal him and that he had great plans for him. We are going to pretend that the popcorn is the good news.*
2. Divide the children into two teams and have them form two lines.



3. Place a bowl of popcorn at the start of each line and another bowl about ten feet away from each starting line.
4. Give the first child in each line a spoon.
5. The object is to carry the spoon, with a piece of popcorn, to the other side of the room and drop the popcorn into the bowl. Then, to bring the spoon back to the next person in line.
6. The next person in line repeats this until all of the children in the line have had a turn.
7. If the popcorn falls, the child simply stops and picks it up, puts it back in the spoon, and continues walking.

#### Teacher Tips

- As each group finishes, they can clap for each other. Do not let them be competitive with each other. Explain that if they do their best, they will all win in this game.

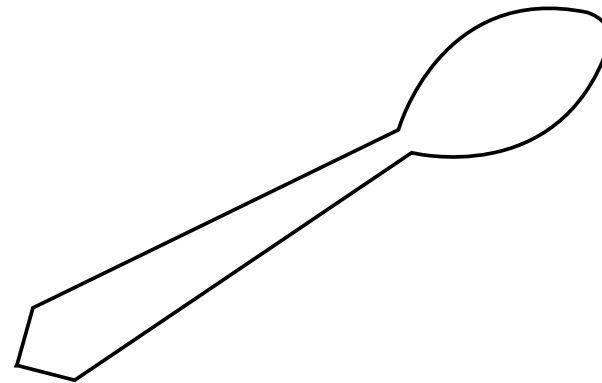

CRAFT

# Ananias Loves Paul

### My Scroll-2

The children will recount the story of Saul's conversion by making a scroll.

#### Materials

*For each child:*

- 1 piece of white paper, 9" x 12"
- crayons
- envelope
- glue stick
- covered toilet paper rolls from the Preclass Activity

*For the teacher:*

- scissors
- tape
- yarn (optional)

*Reproducible Pages:*

- Page B, 1 copy for each child

#### Preparation

1. Cut out the pictures from the copies of Reproducible Page B.
2. Place one set of pictures into an envelope for each child.
3. Cut each piece of white paper in half making two 4½" x 12" pieces.
4. Make a model of the craft following the instructions.

#### Instructions

1. Show the children the model of the craft. Retell the story to them using the pictures on your scroll. Saul was going to a city called Damascus to catch disciples and put them in jail. Jesus appeared to him and told him to stop hurting the Christians. When Jesus left, Saul was blind. His friends took him to Damascus where a man named Ananias came and healed him.
2. Give each child two pieces of white paper. Help the children to tape the two pieces together end to end. See Figure A.
3. Help the children to tape an end of the paper onto each covered roll. See Figure B.
4. Give each child an envelope with the pictures in it. Help the children, as a group, to figure out the order of the pictures.
5. Have the children glue their pictures onto the white paper in order.
6. Have the children color the pictures.

#### Conclusion

If time allows, use one of the children's scrolls and have the class tell the story together.

#### Teacher Tips

- Have the children roll up their scrolls and tie them with a piece of ribbon or yarn.

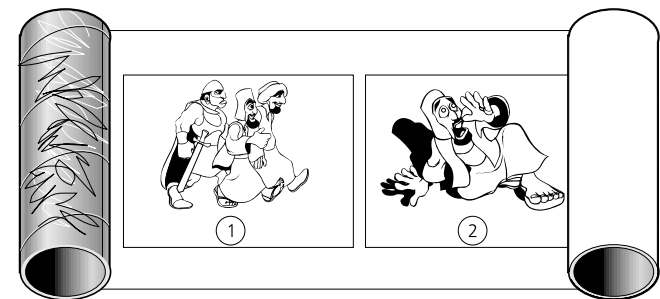

# Ananias Loves Paul

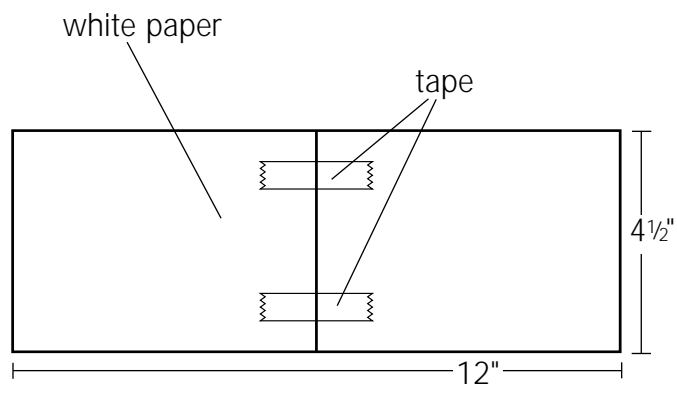

Figure A

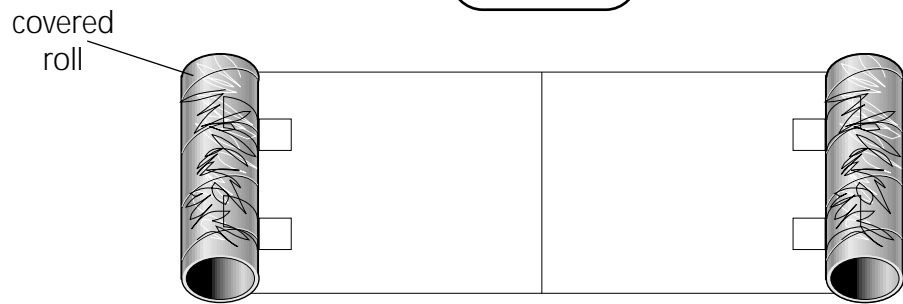
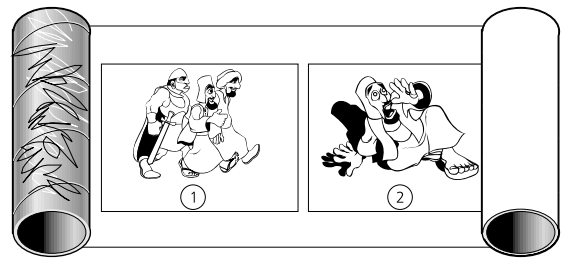
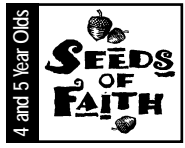

Figure B



Finished Craft



### Meeting New Friends

The children will meet some new adults and will practice being friendly.

#### Scripture Memory Verse

At once he began to preach in the synagogues that Jesus is the Son of God.

*Acts 9:20*

#### Materials

None

#### Preparation

Ask two disciples that most of the children won't know to come to the class. Prepare the adults to be out of themselves and very friendly with the children. Make sure these disciples have been screened for the Children's Ministry. Explain to them that the class is learning the Bible Story in Acts 9.

#### Instructions

1. *In our Bible Story today we are learning about a man named Ananias who God sent to help Saul. Ananias was scared to go see Saul at first. But he went because he knew God wanted him to. Do you sometimes get scared to meet new people? We know that we should never talk to strangers if we don't have our families or another adult with us. But when there is an adult with us we should be very friendly, like Jesus.*
2. *Now, we are going to get a chance to be like Ananias and meet some new people. Ask if any of them are afraid and then pray together. Some of them may want to pray about being friendly and loving.*
3. Have the adults come in and sit with the group.
4. Have each child in the group introduce themselves to the adults.
5. Have the adults introduce themselves and tell a little about where they are from, if they are married, what they do for work, etc.
6. Have the children tell the adults a little about themselves, i.e., who they live with, if they have brothers or sisters, what they are learning in class, etc.

#### Scripture Memory Activity

Choose a child who knows the verse to tell it to the group. Have the visitors try to recite the verse. Have the children help them as necessary.

#### Conclusion

Have the adults and the children pray together to be friendly and obedient as Ananias was. Pray that they will please God as Ananias did. Have the adults pray briefly for someone that they are reaching out to.

#### Teacher Tips

- Be sure to prepare the adults to be friendly and out of themselves.



At once he began to preach  
in the synagogues that Jesus is  
the son of God.

Acts 9:20



Core/Craft  
1 copy for every 10 children

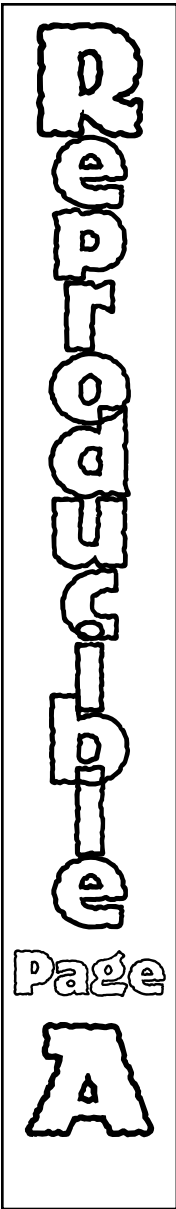

Saul can see!	Saul can see!
Saul can see!	Saul can see!
Saul can see!	Saul can see!
Saul can see!	Saul can see!
Saul can see!	Saul can see!



Supplement/Craft  
1 copy for each child

Missions

Lesson 2

